

Mini Lily

HS509_IB10FSJ

1.0



GENERAL PRODUCT INFORMATION:



This product is ETL listed and suitable only for dry locations and approved for use at any height above the finished floor.



Adjust the Fixture Height

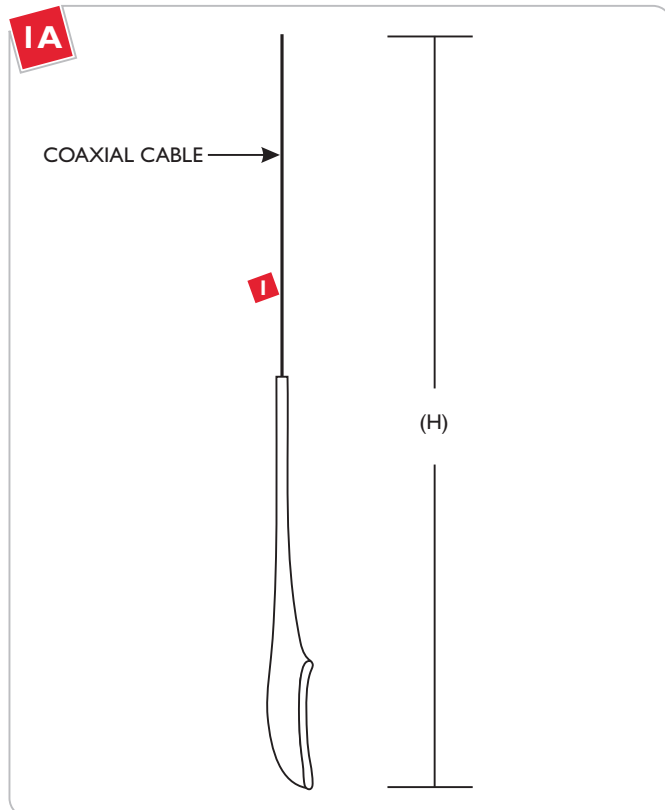

1 Cut the coaxial cable to the desired length with a sharp cutter. The overall fixture height (H) is measured from bottom of the glass shade to end of the coaxial cable.

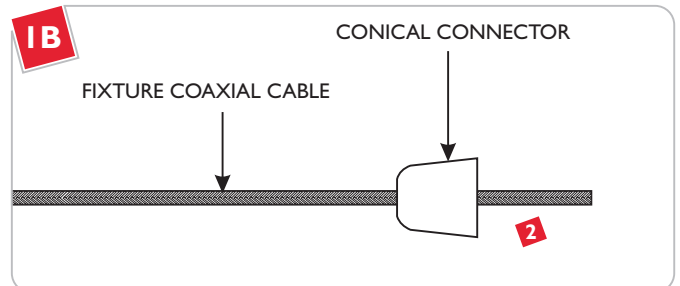

2 Insert the fixture coaxial cable through the conical connector.

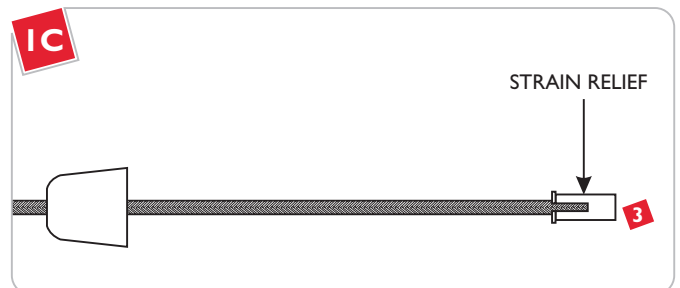

3 Insert the coaxial cable through the flared end of the strain relief.

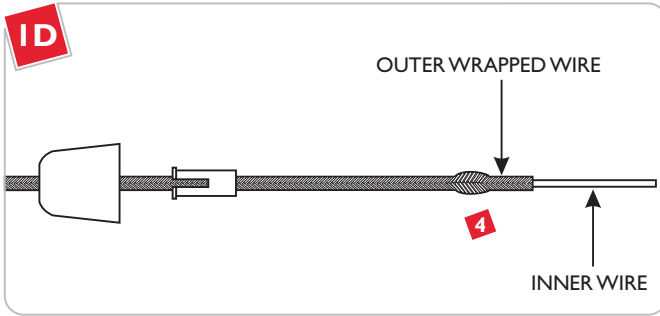

4 Slide the outer wrapped wire back to expose the inner wire.

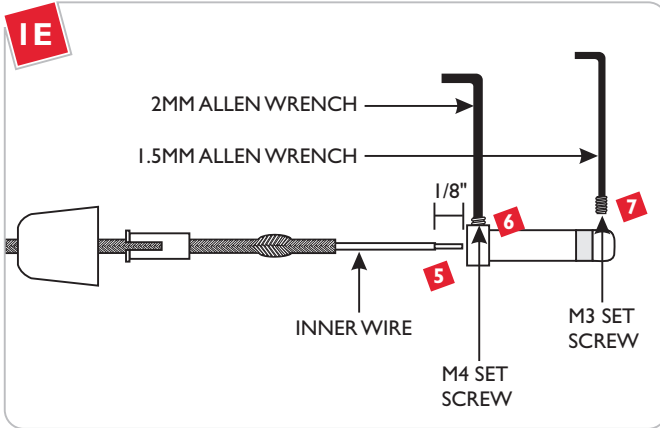

5 Strip 1/8" from end of the inner wire. **Make sure that the stripped portion is not greater than 3/16".**

6 Loosen (**Do Not Remove**) the M4 set screw with the provided 2MM Allen wrench.

7 Remove the M3 set screw with the provided 1.5MM Allen wrench.

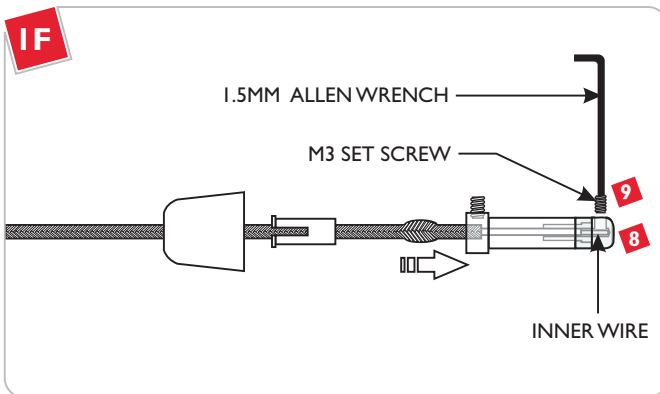

8 While inserting the inner wire into the connector look through the set screw hole to make sure that the stripped portion of the inner wire contacts end of the connector.

9 Hold the coaxial cable in place; replace and tighten the M3 set screw with the 1.5MM Allen wrench. **Lightly** tug on the coaxial cable to make sure that the set screw connection is tight.

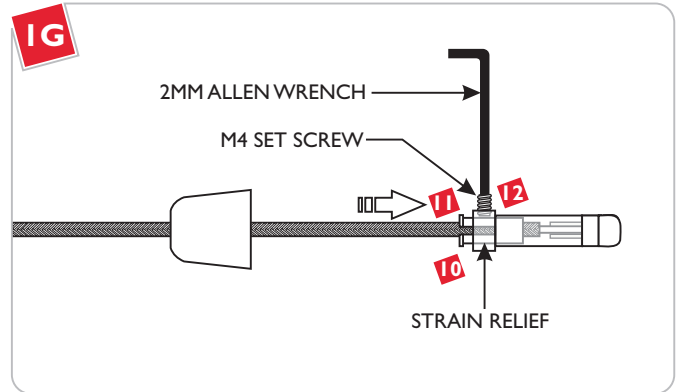

10 The strain relief slots should be rotated 90° away from the M4 set screw.

11 Slide and push the strain relief completely into the connector. This will force the outer wrapped wire to be inserted into the connector.

12 Tighten the M4 set screw with the 2MM Allen wrench so that the strain relief holds the outer wrapped wire in place.

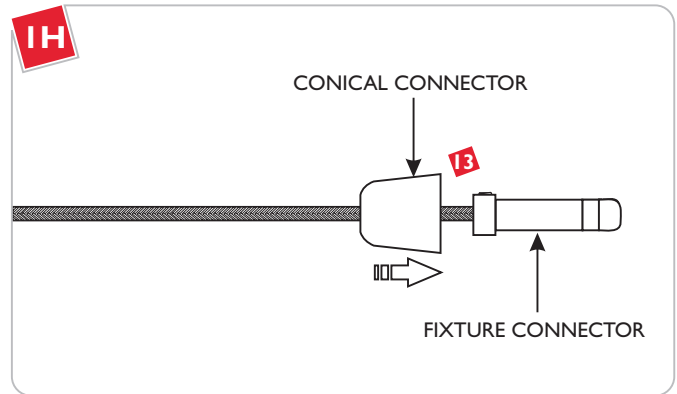

13 Slide the conical connector over the fixture connector. To install the fixture, refer to the instructions provided with the system.

Install the Lamp

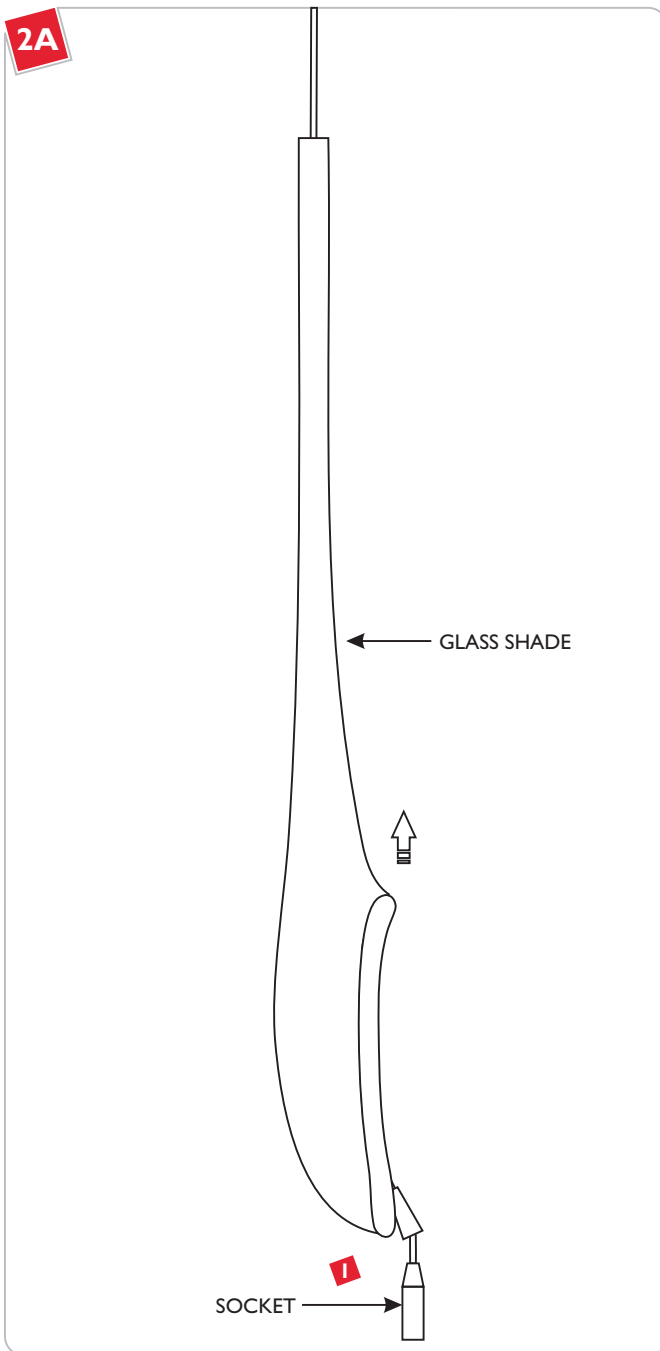

NOTE: To reduce the risk of a burn or electric shock during relamping, disconnect the power to the fixture.

- 1 Lift the glass shade up to expose the socket.

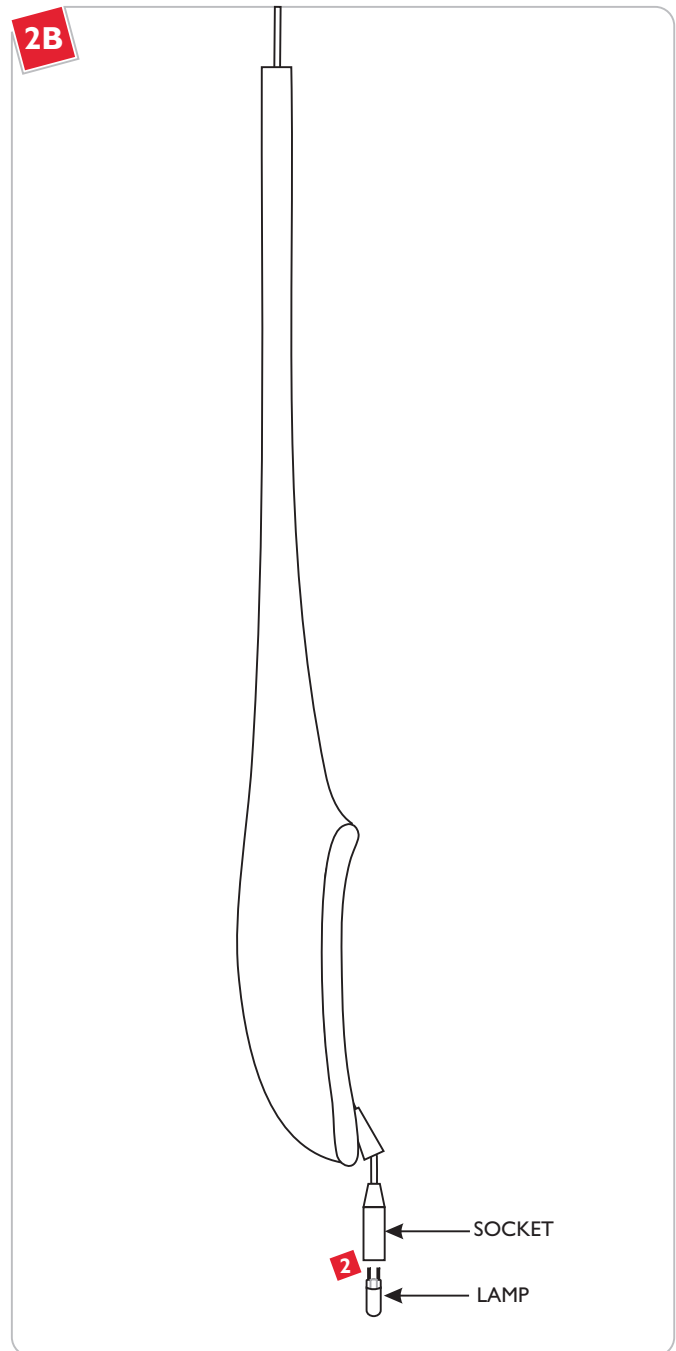

NOTE: Use only your fingers and soft cloth to replace the lamp. A **10 watt** lamp is recommended.

Use **MAX 20 Watt** Type Xelogen (Xenon) Bi-Pin Lamp.



- 2 Push the lamp pins completely into the socket holes.

WARNING: RISK OF FIRE

Never replace a Xelogen (Xenon) lamp with a regular Halogen lamp. A regular Halogen lamp requires a protective glass shield.

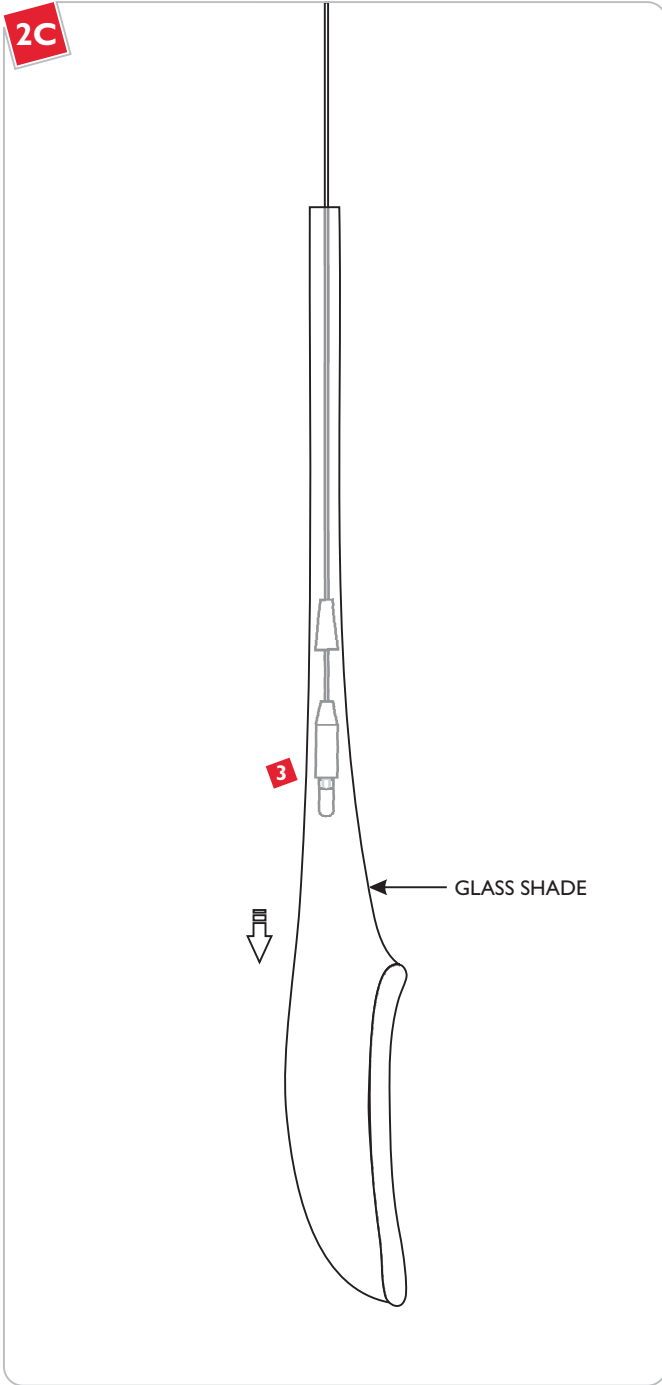

3 Lower the glass shade onto the socket assembly.

SAVE THESE INSTRUCTIONS!



7400 Linder Ave, Skokie, IL 60077

800.323.3226 - 847.626.6300

www.lblighting.com

© 2008 LBL Lighting. All rights reserved. The "LBL Lighting" graphic is a registered trademark of LBL Lighting. LBL Lighting reserves the right to change specifications for product improvements without notification.

A Generation Brands Company